



MADE IN THE USA

### Companion Products (sold separately):

- KS022-0012: Dual-Sided Floor Stand (shown below)
- 13-207: VHB Tape - Clear - 2" x 8.125"



### Product Description:

- Face Mask Dispenser - Bulk - Locking - Short
- Holds contents of two - three boxes of earloop or tie face masks or other items in bulk
- Locking pivot hinge lid
- Top loading, bottom dispensing
- Keyholes for wall mounting
- Clear PETG Plastic

### Primary Area for Product Usage:

- Anywhere face masks are needed in large quantities

### Dispenses:

- Standard earloop or tie face masks or miscellaneous items in bulk

### Product Specifications (overall external dimensions):

- 8.38"W x 10.00"H x 4.43"D (21.3 cm x 25.4 cm x 11.3 cm)
- 1.4 lbs (0.6 kg) - approximated

### Mounting Specifications:

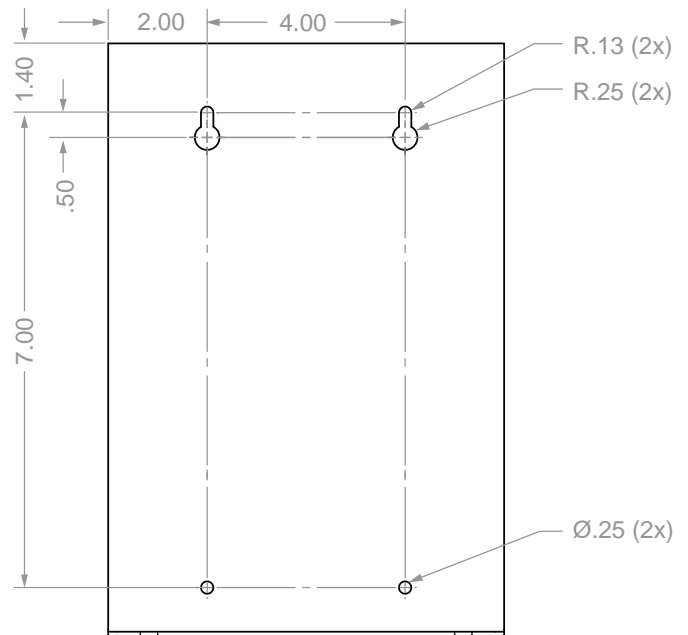

### Package Specifications:

- Package Quantity: 6 per case
  - 18"W x 16"H x 10"D (45.8 cm x 40.6 cm x 25.4 cm)
  - 9.0 lbs (4.1 kg) - approximated
- Package Quantity: 1 per case
  - 12"W x 10"H x 9"D (30.5 cm x 25.4 cm x 22.9 cm)
  - 2.0 lbs (0.9 kg)





## Installation

Always mount dispensers securely *prior* to loading with product.

- Clear design enables view of contents and supply level.
- Hingeless lid and bottom dispensing protects contents from dust and debris.

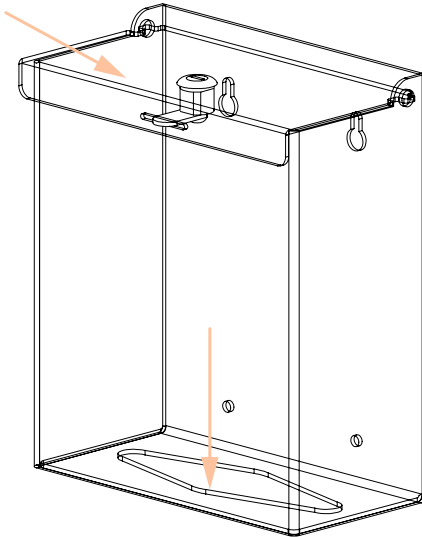

1

- Mount securely to a wall with screws approved and supplied by building maintenance.
- Dispenser can also be mounted to one or both sides of the BOWMAN® Dual-Sided Floor Stand, KS022-0012, with VHB tape. (each purchased separately)

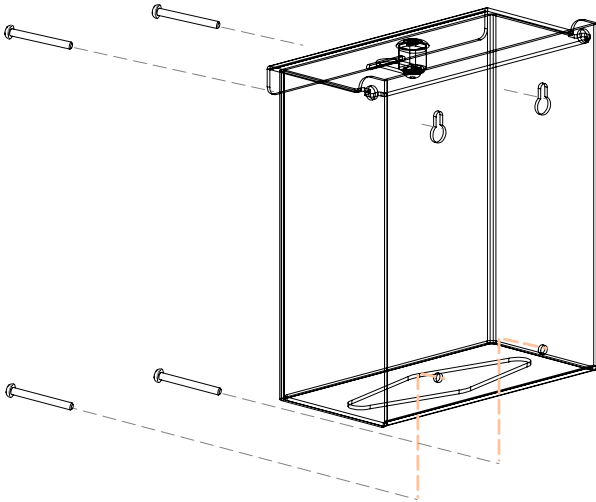

2

### Parts included:

- Dispenser
- 2x keys

### Tools Required:

- No tools required to assemble dispenser

## Care and Construction

### PETG Plastic

### Material Characteristics

### Designed for Long-Term Heavy-Duty Applications

Copolyester resin is designed for heavy-duty applications, and is used by BOWMAN® Dispensers. We never use acrylic in our products.

Copolyester (PETG) is typically 15-20 times tougher than general purpose acrylic. PETG is made to withstand handling and reduce losses due to breakage.

PETG resists a variety of chemicals and commonly used cleaning agents. It is tough and durable (not brittle), providing years of trouble-free functionality and long life.

Clear optical characteristics mean the viewer can see the content, read text, and see true colors through the material. It complies with FDA regulations for food contact.

### Care and Cleaning

Most cleaning chemicals do not weaken the surface or cause damage to the material. Suggested cleaning method is to use a soft cloth, warm water, and mild soap.