



MADE IN THE USA

Companion Products (sold separately):

- FM404-0111: Face Mask Dispenser - Bulk - Locking - Short (shown below)



Product Description:

- Face Mask Dispenser - Bulk - Locking - Short
- Holds contents of two - three boxes of earloop or tie face masks or other items in bulk
- Locking pivot hinge lid
- Top loading, bottom dispensing
- Supply level view slot
- Keyholes for wall mounting
- BOWMAN® *Signature Series* Cherry ABS Plastic

Primary Area for Product Usage:

- Anywhere face masks are needed in large quantities

Dispenses:

- Standard earloop or tie face masks or miscellaneous items in bulk

Product Specifications (overall external dimensions):

- 8.38"W x 10.00"H x 4.43"D (21.3 cm x 25.4 cm x 11.3 cm)
- 1.4 lbs (0.6 kg) - approximated

Mounting Specifications:

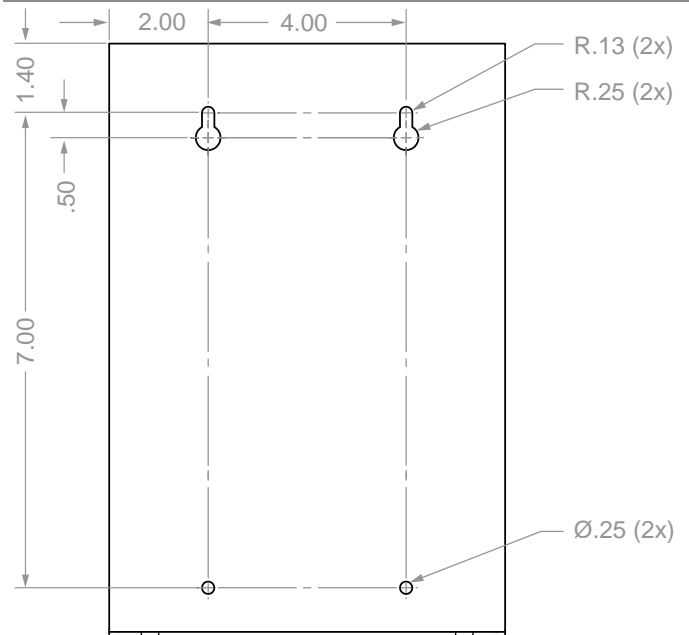

Package Specifications:

- Package Quantity: 6 per case
 - 18"W x 16"H x 10"D (45.8 cm x 40.6 cm x 25.4 cm)
 - 9.0 lbs (4.1 kg) - approximated
- Package Quantity: 1 per case
 - 12"W x 10"H x 9"D (30.5 cm x 25.4 cm x 22.9 cm)
 - 2.0 lbs (0.9 kg)





Installation

Always mount dispensers securely *prior* to loading with product.

- Supply level view slot enables tracking of contents and supply level.
- Hingeless lid and bottom dispensing protects contents from dust and debris.

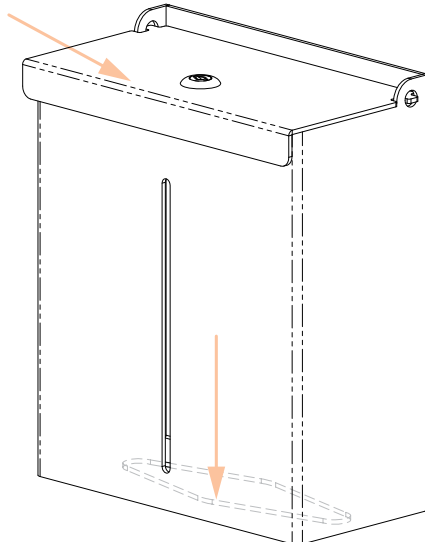

- Mount securely to a wall with screws approved and supplied by building maintenance.
- Dispenser can also be mounted to one or both sides of the BOWMAN® Dual-Sided Floor Stand, KS022-0012, with VHB tape. (each purchased separately)

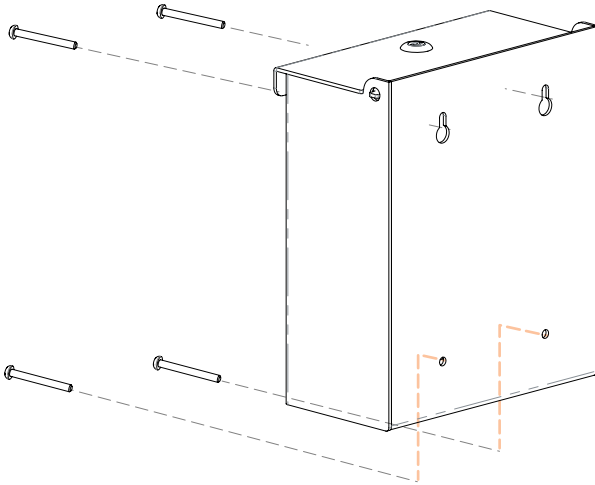

Parts included:

- Dispenser
- 2x keys

Tools Required:

- No tools required to assemble dispenser

Care and Construction

Fauxwood ABS Plastic

Material Characteristics

Designed for Long-Term Heavy-Duty Applications

The combination of copolymers (Acrylonitrile, Butadiene, and Styrene) gives ABS an excellent combination of strength, rigidity, and toughness. The fauxwood finish is ARVINYL laminate created from a semi-rigid film.

ABS is chemical and stress-crack resistant. It is tough, dimensionally stable, and will hold up to long-term use. To ensure product longevity, fauxwood products should not be mounted in very hot or cold areas.

Our fauxwood material is engineered to have a natural grain appearance both in Cherry and Maple finishes. The two color choices provide a visually appealing, upscale option to any area.

Care and Cleaning

BOWMAN® *Signature Series* products can be cleaned with standard hospital cleaning products. Petroleum-based oils, solvents, and paints should not be used. Standard hospital cleaning supplies are approved for use on our fauxwood products.